

■ Standard equipment □ Optional equipment — Not available

Safety	M6 Coupé	M6 Convertible
Active headrest, front	■	■
Airbags:		
– Driver and front passenger airbags, seat occupancy detector for front passenger airbag	■	■
– Head airbags for driver and front passenger	■	—
– Side airbags for driver and front passenger	■	■
Anti-lock brake system (ABS)	■	■
Brake Force Display	■	■
Brake light, third	■	■
Brakes:		
– Compound disc brakes, inner-vented and cross-drilled all round	■	■
Central locking with electronic immobiliser, crash sensor; fuel tank filler flap integrated in central locking	■	■
Child seat fastening ISOFIX in the rear	■	■
Dynamic Stability Control (DSC) , two-stage	■	■
– M Dynamic Mode	■	■
Roll-over safety system (reinforced A-pillars and upper windscreen frame, roll-over bars integrated in rear headrests)	—	■
Safety battery terminal	■	■
Safety bodysell:		
– Deformation zones front and rear, door reinforcements made of aluminium, bumpers regenerating to their original position in impacts at up to 4 km/h	■	■
– Side impact protection, integrated	■	■
Seat belts:		
– Ergonomic belt system at the rear with three-point belts on all seats	■	■
– Inertia-reel seat belts at the front with pyrotechnical belt tensioner, belt force limiter and belt retainer	■	—
– Seat-integrated belt system with inertia-reel seat belts in the front, pyrotechnical belt latch tensioner, adaptive belt force governor and belt restraint	—	■

Exterior design	M6 Coupé	M6 Convertible
Chrome Line Exterior	□	□
Metallic paintwork	■	■
Shadow Line , high-gloss	■	■
Soft top:		
– Fin roof, fully automatic	—	■
– Soft top compartment, variable	—	■
White indicator lights	■	■

Equipment package	M6 Coupé	M6 Cabrio
Competition package includes tuned and lowered suspension, modified ABS and DSC settings and limit values, M light-alloy wheels 167 M double-spoke styling, forged and polished, with sports tyres, contoured engine-compartment lid)	□	—

Wheels	M6 Coupé	M6 Convertible
– M light-alloy wheels in double-spoke styling 167M, 8.5 J x 19-inch wheels and 255/40 ZR 19 tyres at the front, 9.5 J x 19-inch wheels and 285/35 ZR 19 tyres at the rear, forged and polished	■	■
Runflat indicator	■	■

Interior design	M6 Coupé	M6 Convertible
Foot mats in velour	■	■
Interior trim:		
– BMW Individual Piano Finish Black	■	■
– Carbon Fibre	□	□
– Fine-wood trim in Madeira Walnut, red-brown	□	□
– Fine-wood trim in Olive Ash Carrara, natural	□	□
M doorsills	■	■
Upholstery:		
– Full Merino leather ¹ , with additional leather trim (instrument panel, door trim and Alcantara roof lining)	□	□
– Merino leather ¹	■	■

Transmission and technology	M6 Coupé	M6 Convertible
10-cylinder V engine with four-valve technology, individual throttle butterflies with electronic throttle butterfly control	■	■
Aluminium chassis with double-joint spring strut front axle, integral rear axle with M-specific set-up	■	■
Brake Energy Regeneration*	■	■
Centre lock switch	■	■
Digital Engine Electronics (DME)	■	■
Electronic Damper Control with three programmes (Comfort, Normal, Sports)	■	■
Emission standard: EU4	■	■
Exhaust system , twin-chamber with twin dual tailpipes, chrome-plated	■	■
Hydraulic valve play compensation	■	■
Ion flow knock control	■	■
Light-alloy cylinder head	■	■
M Drive	■	■
M high-pressure Double-VANOS	■	■
M Servotronic	■	■
Oil supply with lateral force control	■	■
On-board diagnosis	■	■
SMG Drivelogic , 7-speed	■	■
Variable M differential lock	■	■

¹ BMW M6 Convertible with SunReflective Technology
* Not available in all countries. Please consult your BMW partner.

■ Standard equipment □ Optional equipment — Not available

Driver assistance	M6 Coupé	M6 Convertible
Cruise Control	■	■
Head-up Display with additional M-specific function (dynamic rpm range, shift lights, selected gear, vehicle speed)	■	■
High-beam assistant	□	□
Park Distance Control (PDC)	□	□

Light and sight	M6 Coupé	M6 Convertible
Adaptive Headlights	■	■
Follow-me-Home function	■	■
Glass rear window , vertical, can be raised and retracted independent of soft top	—	■
Headlight washing system	■	■
Indirect illumination (night design)	■	■
Interior lights with automatic function , "soft" on/off	■	■
LIGHTS-ON warning	■	■
M exterior and interior mirrors , with automatic anti-glare function	■	■
Rain sensor incl. automatic driving lights control	■	■
Xenon Headlights for high and low beam , incl. automatic headlight range control	■	■

Interior	M6 Coupé	M6 Convertible
Automatic air conditioning (incl. AAR, fogging and solar sensor)	■	■
Climate comfort windscreen	□	□
Heat insulation glass all-round , green-tinted, with laminated windscreen	■	■
Roofliner in Alcantara (Anthracite)	□	—
Seats:		
– Backrest width adjustment for driver and front passenger seat	■	—
– Comfort entry to the rear	■	■
– Lumbar support for driver and front passenger seat	■	■
– M seats with electric longitudinal, height and backrest angle adjustment, manual thigh support. Driver's seat also features inclination adjustment and memory function.	■	■
– Seat heating for driver and front passenger seat	■	■
Steering wheel:		
– M leather steering wheel with SMG gearshift paddles, multifunction control and MDrive button	■	■
– Steering wheel heating	□	□

BMW Recycling.

Your BMW is the product of a comprehensive recycling concept. But what exactly does this mean in practice? It means that all the requirements of recycling are taken into account from the start, in the initial development of a BMW. One example is the choice of materials carefully selected to preserve resources and ensure efficient recycling compatible with the environment. Each BMW is designed and built for simple and economic recycling after its running life. We have been collecting the know-how required for this purpose ever since 1994 at the unique BMW Recycling and Dismantling Centre (RDC) near Munich. Please contact your BMW partner on all matters regarding the return of your end-of-life vehicle. He will be happy to advise.

Comfort and interior equipment	M6 Coupé	M6 Convertible
Alarm system with remote control	■	■
Armrest at the front	■	■
Comfort access	□	□
Cupholders , front and rear	□	□
Garage door opener , integrated	□	□
Personal profile	■	■
Radio remote control , key with automatically recharging battery	■	■
Ski bag	□	□
Non-smoker package	■	■
Window lifts, electric , with one touch control at the front, trap release and comfort closing function	■	■

Entertainment, communication and information	M6 Coupé	M6 Convertible
BMW ConnectedDrive – Telematics Services*:		
– BMW Assist	□	□
– BMW Online	□	□
– BMW TeleServices	□	□
Control Display	■	■
Controller on the centre console , incl. direct menu control buttons	■	■
Info Display with permanently illuminated (white) displays for vehicle speed, engine speed, fuel level and oil temperature	■	■
Navigation system Professional* incl. preparation for mobile phone Bluetooth with voice control function, BMW Assist* and BMW Online*	□	□
Navigation system Professional* high-definition 8.8" colour display, hard disk drive incl. voice control display	□	□
On-board computer incl. outside temperature display	■	■
Radio/audio:		
– AUX-IN connection	■	■
– BMW Individual High-End Audio System	□	□
– CD changer, 6-discs	□	□
– HiFi loudspeaker system	■	■
– HiFi system Professional LOGIC7	□	□
– Radio BMW Business CD	■	■
– Radio BMW Professional	□	□
– USB/audio interface	□	□
Service interval indicator	■	■
Telephone:		
– Mobile phone preparation Business with Bluetooth interface, incl. BMW Assist*	□	□
TV-function for analogue and digital (DVB-T) reception	□	□

*Not available in all countries. Please consult your BMW partner.

The models illustrated in this brochure show the specifications for the German market. In part, they include optional equipment and accessories not fitted as standard. According to the specific requirements of other markets, alterations in models, standard and optional equipment, as described in the text and illustrations, may occur. For precise information, please contact your BMW partner. Subject to change in design and equipment.
© BMW AG, Munich/Germany. Not to be reproduced wholly or in part without written permission of BMW AG, Munich.

BMW recommends 

Weight		M6 Coupé	M6 Convertible
Kerb weight ¹	kg	1785	2005
Max. permissible	kg	2200	2380
Max. load	kg	490	450
Max. axle load, front/rear	kg	1090/1200	1120/1290

Engine³		M6 Coupé	M6 Convertible
Cylinders/valves		10/4	10/4
Capacity	cc	4999	4999
Stroke/bore	mm	75.2/92.0	75.2/92.0
Max. output/speed	kW(hp)/rpm	373 (507)/7750	373 (507)/7750
Max. torque/speed	Nm/rpm	520/6100	520/6100
Compression ratio	:1	12.0	12.0

Performance		M6 Coupé	M6 Convertible
Top speed	km/h	250 ²	250 ²
Acceleration 0–100 km/h	sec	4.6	4.8
Standing-start 0–1000 m	sec	22.5	22.9

Fuel consumption^{3,4}		M6 Coupé	M6 Convertible
City/highway/combined*	ltr/100 km	21.4/10.2/14.3	22.0/10.6/14.7
CO ₂ emissions*	g/km	342	352
Tank capacity, approx.	ltr	70	70

Wheels		M6 Coupé	M6 Convertible
Tyre dimensions front/rear		255/40 ZR 19/285/35 ZR 19	255/40 ZR 19/285/35 ZR 19
Tyre dimensions front/rear		8.5 J x 19 ET 12/9.5 J x 19 ET 17	8.5 J x 19 ET 12/9.5 J x 19 ET 28
Material		Light-alloy, forged	Light-alloy, forged

Electrical system		M6 Coupé	M6 Convertible
Battery capacity	Ah	90	90
Alternator output	A	170	170

¹ The figure specified includes a 90% tank filling plus 68 kg for the driver and 7 kg for luggage. Unladen weight applies to vehicles with standard equipment. Options and special equipment may increase this figure.

² Electronically limited.

³ The engine of the BMW M6 Coupé and the BMW M6 Convertible is designed for RON 98 fuel. Use of RON 95 or 91 fuel reduces engine output.

⁴ The engine of the BMW M6 Coupé and the BMW M6 Convertible fulfils the EU4 emission standard. Fuel consumption is determined in the ECE driving cycle made up of approximately one-third urban and two-thirds overland driving (measured in terms of mileage covered). CO₂ emissions are measured in addition to fuel consumption. Optional equipment (such as wider tyres) can have a significant impact on fuel consumption.

Optional extras are available fully installed straight from the factory. For additional extras see the extensive catalogue of accessories at your BMW partner. BMW Individual will be happy to help should you wish your dream BMW to include features not listed here. To find a package that perfectly suits what you have in mind, simply contact your BMW partner for assistance.

*May vary by country.

BMW M6 Coupé

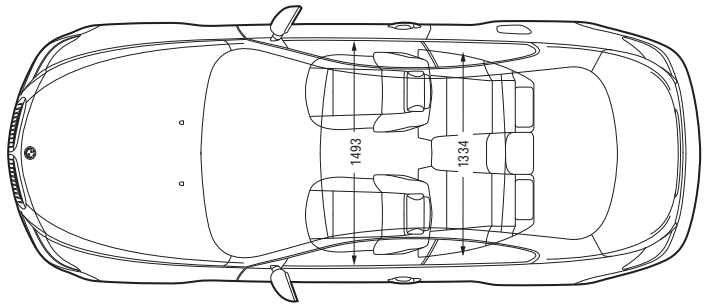
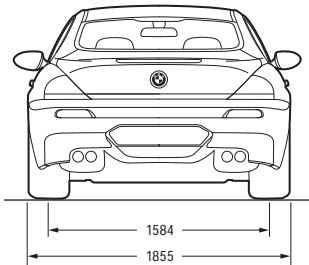
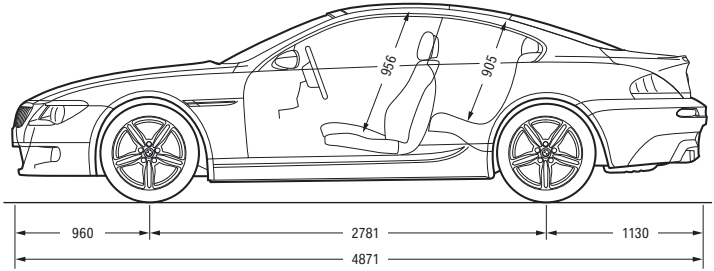
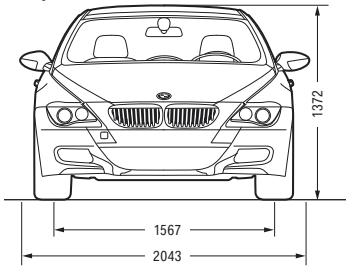

BMW M6 Convertible

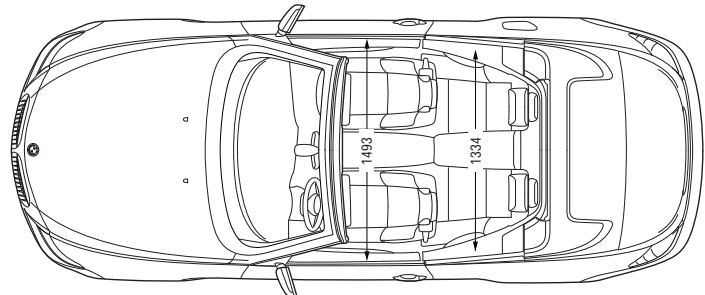
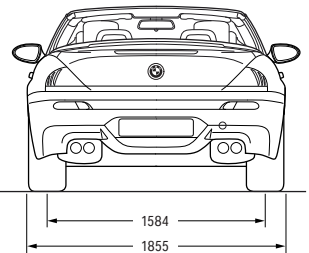
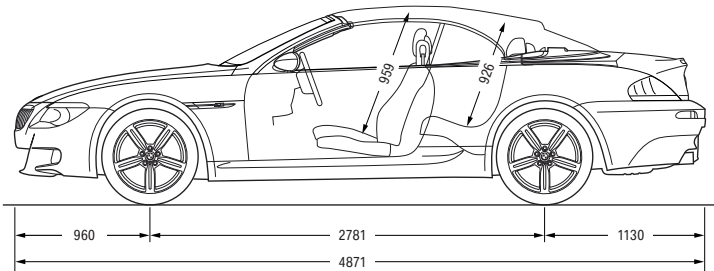
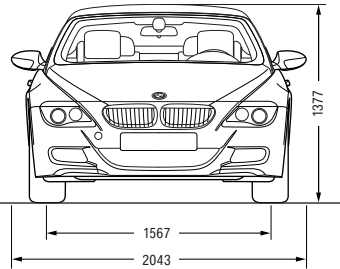

All dimensions of technical drawings in millimetres. Luggage compartment capacity for the BMW M6 Coupé is 450 litres and for the BMW M6 Convertible is 300-350 litres (measured to VDA standard).