



# THE X2



# THE BMW X2.



# INNOVATION AND TECHNOLOGY.



18 Powertrain and Suspension



20 Driver assistance  
21 Safety



22 Connectivity and infotainment  
23 Comfort and functionality

# EQUIPMENT.

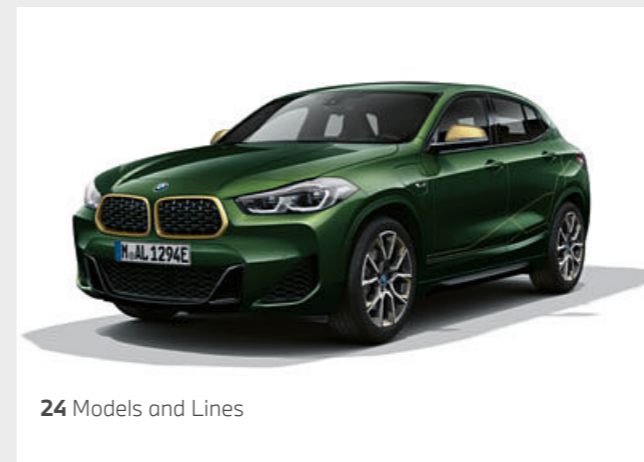

24 Models and Lines



32 Additional equipment

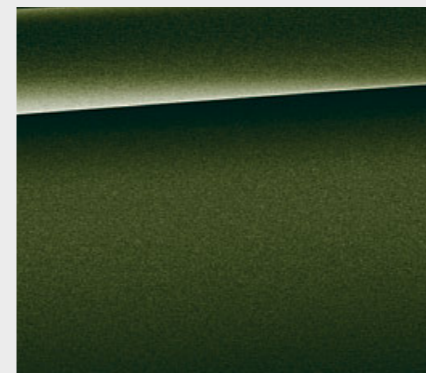

36 Exterior colours

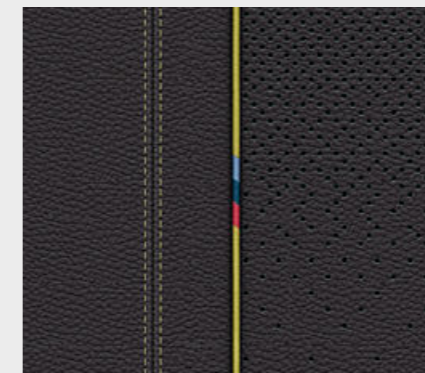

38 Interior colours



40 Wheels and tyres



## ALL BMW MODELS IN ONE APP.

DOWNLOAD THE **BMW Products** APP NOW  
AND DISCOVER THE PLEASURE OF DRIVING.



41 Original BMW Accessories

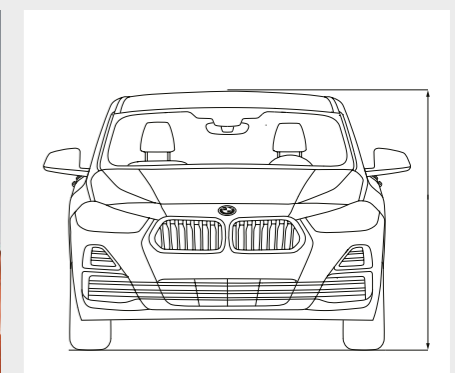

42 Technical data

















■ Standard equipment □ Optional equipment



## ENGINE HIGHLIGHTS OF THE BMW X2.

### BMW M35i

BMW TwinPower Turbo 4-cylinder petrol engine with 225 kW (306 hp) and 450 Nm torque  
Acceleration 0–100 km/h: [4.9] s  
Top speed: [250]<sup>3</sup> km/h  
Combined consumption<sup>1,2</sup>: [8.1-7.5] l/100 km  
Combined CO<sub>2</sub> emissions<sup>1,2</sup>: [185-170] g/km

### BMW xDrive25e<sup>5</sup>

Plug-in hybrid drive with BMW TwinPower Turbo 3-cylinder petrol engine and an electric motor with 162 kW (220 hp) system power and 385 Nm system torque.  
Acceleration 0–100 km/h: [6.8] s  
Top speed: [195] km/h  
Electric top speed: [135] km/h  
Combined fuel consumption<sup>1,2</sup>: [1.8-1.7] l/100 km  
Combined CO<sub>2</sub> emissions<sup>1,2</sup>: [42-38] g/km

□ The **adaptive suspension**\* with a lowering of ten millimetres makes it possible to adjust the damper characteristics to suit the driving situation and combines ride comfort and driving dynamics with the best possible safety. Via the Driving Experience Control, the driver can choose the standard COMFORT mode or the SPORT mode.

□ The **M Sports steering**<sup>4,\*</sup> with Servotronic creates a direct and agile steering response and ensures less physical effort is required to turn the wheel. The vehicle can be directed more precisely, offering highly athletic handling characteristics, particularly on winding roads. It also makes steering easier while parking, turning and manoeuvring.

□ **M Sport suspension**<sup>4,\*</sup> – which includes a chassis which is lowered by 10 millimetres – is characterised by more athletic suspension settings. In addition to shorter bearing springs, it also encompasses tighter damper settings. Together these lead to a lower centre of gravity. This results in even more direct settings, along with reduced body roll, leading to improved agility.

□ The **M Sport brake**\* has four-piston fixed calipers at the front and single-piston floating calipers at the rear in Red high-gloss with M lettering and features larger brake discs to ensure an outstanding braking performance. Adapted to the vehicle's very high dynamic potential, it also allows an exceptional athletic driving style and excellent braking on wet surfaces.

<sup>2</sup> Official data for fuel consumption, CO<sub>2</sub> emissions, power consumption and electric range was determined in accordance with the prescribed measuring procedure and corresponds to European Regulation (EU) 715/2007 in the applicable version. For ranges, data determined as per WLTP takes into account any optional equipment (available on the German market in this case). For vehicles that have been newly type approved since 1 January 2021, only the official data according to WLTP exists. For more information about NEDC and WLTP measuring procedures visit [www.bmw.com/wltp](http://www.bmw.com/wltp)

<sup>1</sup> The EC unladen weight refers to a vehicle with standard equipment and does not include any optional extras. The unladen weight includes a 90% full tank and a driver weight of 75 kg. Optional equipment may affect the weight of the vehicle, the payload and the top speed if the selected equipment has an impact on the vehicle's aerodynamics.

### 7-SPEED STEPTRONIC SPORT TRANSMISSION

□ The 7-speed Steptronic Sport transmission\* with double clutch offers incredibly sporty gear changes. Whether automatic or manual using gearshift paddles or gear lever – for comfortable coasting or incredibly dynamic driving. In SPORT mode and with the gear lever in the left-hand S/M position, the gear shifts are configured for maximum performance.

### 8-SPEED STEPTRONIC SPORT TRANSMISSION

□ The 8-speed Steptronic transmission<sup>4,\*</sup> ensures particularly smooth gearshifts and outstanding driving comfort, thanks to fast engine speed transitions and tightly spaced gear ratios. It unites superb comfort with impressive dynamics and increased fuel efficiency.

### BMW ALL-WHEEL DRIVE SYSTEM xDRIVE

■ The intelligent BMW xDrive all-wheel drive system smoothly and variably distributes drive power to the front and rear wheels for maximum traction, driving dynamics and safety in every driving situation. For even better agility, the electronically controlled power distribution for instance counterbalances oversteer or understeer on bends.

### DRIVING EXPERIENCE CONTROL

■ The Driving Experience Control lets the driver choose between the standard COMFORT mode, ECO PRO Mode which is geared towards efficiency, and SPORT mode which enables even more dynamic driving. ECO PRO mode adjusts the characteristics of the accelerator, Steptronic transmission and the heating/air conditioning settings to make the drive as fuel-efficient as possible.

### STANDARD SUSPENSION

■ Agility, outstanding steering characteristics and impressive comfort are the hallmarks of the suspension's driving behaviour. The front single-joint trailing-arm axle, compact multi-arm rear axle with separate spring/damper arrangement and high level of body rigidity lay the foundations for this excellence. Its axle kinematics, gas-filled shock absorber and stabilisers are extremely dynamics-oriented.



<sup>3</sup> Electronically limited.

<sup>4</sup> Standard for BMW X2 M35i.

<sup>5</sup> At temperatures below freezing, the fully electric drive system on this plug-in hybrid is only available after a few kilometres of driving, once the battery has heated to operational temperature.

Figures in [ ] are for vehicles with Steptronic transmission.

\*The availability of some equipment features and functions depends on engine variants or additional options. The market and production availability may vary. You can find detailed information about terms, standard and optional equipment at [www.bmw.com](http://www.bmw.com) or at your BMW Partner.

# DRIVER ASSISTANCE.

□ The **Driving Assistant Plus<sup>1</sup>\*** equipment provides a clear improvement in safety and comfort. It includes the Collision Warning and Pedestrian Warning with light city braking function, Lane Departure Warning, the High-beam assistant, the speed limit info and the camera-based cruise control with Stop&Go function.

□ The camera-based **cruise control with Stop&Go function\*** maintains your preselected speed, as well as the distance to the driver ahead. The vehicle takes over accelerating and braking and keeps the predetermined distance to the vehicle ahead even in slow-moving traffic and down to a stand-still in traffic jams.

■ The optional **Hill Descent Control (HDC)\*** in the xDrive models is a system which, when activated, ensures that the vehicle can master the steepest downhill runs automatically and safely at just above walking pace, without the driver having to brake.

□ The **Parking Assistant<sup>2</sup>\*** makes parallel parking easier. The system works by measuring potential spaces while driving past them at a low speed. When a suitable space has been found, the Parking Assistant takes over steering, while you are responsible for selecting the correct gear, as well as pressing the accelerator and brake.



# SAFETY.

■ Standard equipment □ Optional equipment



□ Adaptive LED headlights with low-beam and high-beam headlights include LED turn indicators, adaptive light control and High-beam Assistant.



■ The Attentiveness assistant checks the driver's behaviour for signs of fatigue and recommends that the driver take a break if necessary.

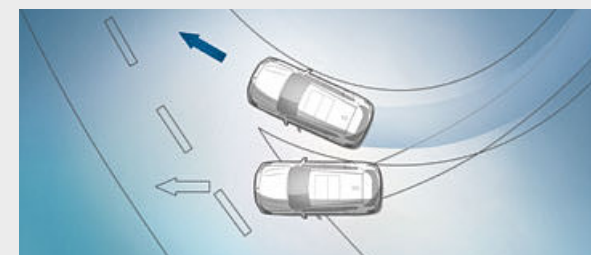

■ Dynamic Stability Control (DSC) constantly assesses the vehicle's ongoing movements and optimises driving stability and traction.

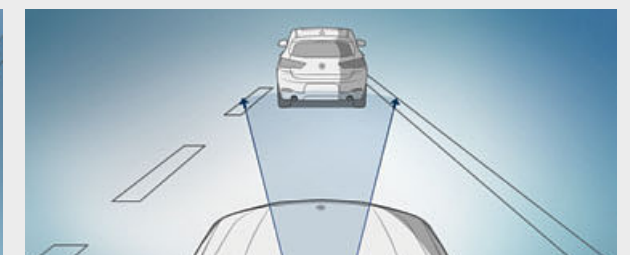

□ The Driving Assistant safety package<sup>1</sup> \* draws the driver's attention to an unintentional lane change or possible collision and brakes automatically in the event of an emergency.

<sup>1</sup> Function may be limited in darkness, fog or bright glare.

<sup>2</sup> The driver is responsible for constantly monitoring the automated parking procedure in accordance with local road laws.

\*The availability of some equipment features and functions depends on engine variants or additional options. The market and production availability may vary. You can find detailed information about terms, standard and optional equipment at [www.bmw.com](http://www.bmw.com) or at your BMW Partner.

# CONNECTIVITY AND INFOTAINMENT.

BMW ConnectedDrive  
So connected, you're free.



## INSTRUMENT CLUSTER IN BLACK PANEL TECHNOLOGY

■ The instrument cluster in Black Panel technology features four analogue displays – speed, engine revs, fuel gauge and current consumption – as well as an Info Display showing the outside temperature, motor oil temperature and various functions of the on-board computer.

## CONCIERGE SERVICE

□ Will the sun shine in Rome tomorrow? What time is my flight? The Concierge Service\* is there for you on the road and supports you with all concerns at the touch of a button. Be it reservations in a restaurant, hotel or cinema. Even payment is possible with it. Wherever you are, whatever you need, the Concierge Service is by your side.

## APPLE CAR PLAY® PREPARATION

□ Why go without the features of your iPhone in your BMW when you can continue operating it as usual? The Preparation for Apple CarPlay®<sup>1</sup> gives you remote access to telephony as well as apps like iMessage, WhatsApp, TuneIn, Spotify and Apple Music. You can also use the voice button on the steering wheel to access Siri, Apple's voice assistant.

## REAL TIME TRAFFIC INFORMATION

□ Wasting holiday time in traffic jams? With Real Time Traffic Information\* you reach your destination faster. The service knows the current traffic situation almost in real time and automatically calculates alternative routes. The additional Local Hazard Preview warns you of adverse road conditions or accidents on your route.

## TELEPHONY WITH WIRELESS CHARGING

□ Telephony with wireless charging<sup>2</sup> includes a wireless charging dock and an additional USB port. A roof aerial connection improves mobile reception. Two mobile telephones and an audio player can be connected simultaneously via Bluetooth. In addition, there is Bluetooth Office.

## HIFI LOUDSPEAKER SYSTEM

□ The HiFi loudspeaker system featuring a 205 watt amplifier and seven speakers provides an even distribution of sound throughout the interior of the vehicle. The 7-channel amplifier guarantees that the audio will be finely tuned for a superbly crisp sound.

# COMFORT AND FUNCTIONALITY.

Innovation and Technology 22 | 23

■ Standard equipment □ Optional equipment

□ The **Comfort access** allows passengers to enter the vehicle via the front doors and to open the tailgate without having to actively use the key. The key must simply be nearby, in the driver's trouser pocket for example. To unlock the doors, it is only necessary to touch the handles or the tailgate button.

□ **Automatic tailgate operation** allows convenient opening and closing of the tailgate – simply press the button in the door trim panel on the driver's side or on the vehicle key. The tailgate can also be opened in the conventional manner, using the outside handle, and closed pressing a button on the inside of the tailgate.

□ The **Automatic air conditioning** with 2-zone control and automatic target temperature control features separate controls for you and your front passenger. It also includes automatic air recirculation control, a micro active carbon filter, a condensation and solar sensor, as well as rear air vents.

□ Depending on the equipment, **Multifunction for steering wheel** can be used to operate the telephone, voice control and audio functions via the buttons on the steering wheel. The Manual Speed Limiter is also integrated. It can be used to set an upper limit of 50 km/h for city driving, for example.

□ The **electrical seat adjustment** makes it particularly convenient and easy to adjust the driver and front passenger seats. The memory function enables the driver to save and retrieve their desired settings for the driver's seat and exterior mirrors at the push of a button.



<sup>1</sup> Apple CarPlay® compatibility and supported functions depend on the model year and the software installed on the iPhone®. When the Apple CarPlay® preparation is in use, selected vehicle data is transferred to the phone. The mobile phone manufacturer is responsible for further data processing.

<sup>2</sup> Supports inductive charging for Qi-compatible mobile phones. Special charging cases are available from Original BMW Accessories for selected smartphones that do not support the Qi standard for inductive charging.

\*The availability of some equipment features and functions depends on engine variants or additional options. The market and production availability may vary. You can find detailed information about terms, standard and optional equipment at [www.bmw.com](http://www.bmw.com) or at your BMW Partner.

Some ConnectedDrive Services may differ between countries. Please consult your local BMW partner for more information.

# BASE.

Discover even more with the new BMW Products app. Available now, for your smartphone and tablet.



■ In the BMW X2, classic BMW driver orientation, the dynamic lines of the decorative surfaces and decorative stitching on the instrument panel combine to create an exclusive space focused on the driving experience. The interior trim finishers in Oxide Silver dark matt with highlight trim finishers Black high-gloss visually stretch the interior in a horizontal way.

### Selected base model equipment features:

- 17" light alloy wheels V-spoke style 560
- Standard seats, front incl. seat length, seat height and backrest tilt adjustment in Grid cloth, other upholstery available
- Air conditioning
- Storage package incl. stainless steel edge trim
- Media with 6.5" Control Display and BMW iDrive Controller, voice control with Bluetooth connectivity incl. audio streaming for compatible smartphones and USB interface
- LED headlights with extended functionality, rear lights with LED technology
- Driving Experience Control
- Performance Control
- Servotronic
- Leather steering wheel
- Rain sensor with automatic headlight activation
- Six loudspeakers, 100 watts
- 2.7" instrument cluster with black panel technology



■ 17" light alloy wheels V-spoke style 560 in Reflex Silver, wheel size 7.5J x 17 with 225/55 R17 tyres.

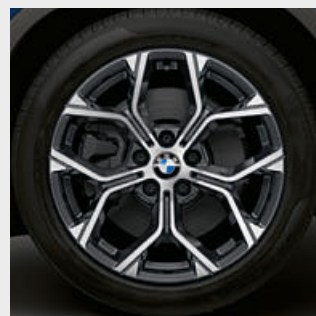

□ 18" light alloy wheels Y-spoke style 579 Bicolour Orbit Grey, gloss-lathed, wheel size 7.5J x 18 with 225/50 R18 tyres.

# M SPORT PACKAGE.

Equipment 24 | 25



■ Standard equipment □ Optional equipment



■ M Leather steering wheel including multifunction buttons, steering wheel rim in leather 'Walknappa' Black with contoured thumb rests.

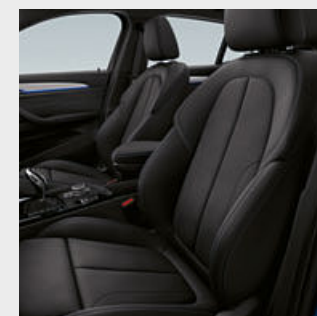

■ The sport seats can be adjusted to a variety of positions. They have high seat and backrest bolsters, providing optimal support for the driver and front passenger even when driving swiftly through bends.

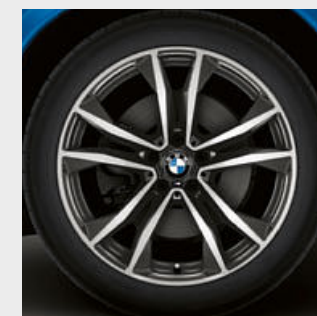

■ 19" M light alloy wheels Double-spoke style 715 M, Orbit Grey, gloss-lathed with runflat tyres, wheel size 8J x 19 with 225/45 R19 tyres.

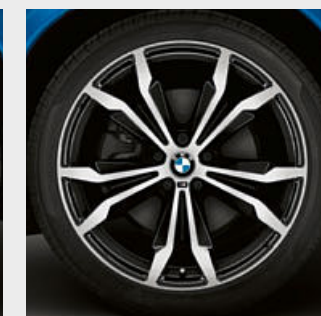

□ 20" M light alloy wheels Double-spoke style 716 M, Jet Black, gloss-lathed with runflat tyres, wheel size 8J x 20 with 225/45 R20 tyres.

### M Sport package exterior equipment:

- M Aerodynamics package including front apron with insert in Dark Shadow metallic, specially designed air inlets and side sills in the body colour with inserts in Dark Shadow metallic, wheel arch trim and claddings in the body colour and rear apron with diffuser insert in Dark Shadow metallic
- 19" M light alloy wheels double spoke style 715 M with run-flat tyres; other wheels available
- M Sport suspension, lowered\*
- M high-gloss Shadow Line
- M designation on the sides
- Exclusive paintwork in M Misano Blue metallic; other paintwork available

### M Sport package interior equipment:

- M front entry sills, M driver's footrest and M pedals
- Floor mats with exclusive M designation
- Sport seats for driver and front passenger in cloth 'Micro Hexagon' Sensatec Black or Anthracite Cloth/Sensatec with Grey highlights; other upholsteries available
- M leather steering wheel
- Vehicle key with exclusive M designation
- M anthracite headliner
- M interior trim finishers Aluminium Hexagon with highlight trim finishers in Estoril Blue matt; other trims available
- Gear lever with M designation<sup>1</sup>
- Exclusive LED optical fibre in the door trims

<sup>1</sup> Only available in conjunction with manual transmission.

\*The availability of some equipment features and functions depends on engine variants or additional options. The market and production availability may vary. You can find detailed information about terms, standard and optional equipment at [www.bmw.com](http://www.bmw.com) or at your BMW Partner.

# M SPORT X PACKAGE.

Discover even more with the new BMW Products app. Available now, for your smartphone and tablet.



■ Standard equipment □ Optional equipment



■ The M leather steering wheel with high-grip rim, the M driver footrest and the Aluminium Hexagon Anthracite M interior trim with Pearl Chrome finishers emphasise the dynamic orientation of the interior.



■ The excitingly designed Sport seats in cloth 'Micro Hexagon' Sensatec Black with Yellow highlights set visual highlights in the interior and provide comfortable support.

## M Sport X Line exterior equipment:

- M Sport X exterior package including front apron with insert in Frozen Grey metallic, specially designed air inlets and side sills in Frozen Grey metallic with inserts in the body colour, wheel arch trim, claddings and rear apron diffuser insert in Frozen Grey metallic
- 19" M light alloy wheels Y spoke style 722 M with emergency running properties; other wheels available
- M Sport suspension, lowered\*
- M high-gloss Shadow Line
- M designation on the sides
- Exclusive M Misano Blue metallic paintwork; other paintwork available

## M Sport X Line interior equipment:

- M front entry sills, M driver's footrest and M pedals
- Sport seats for driver and front passenger in cloth 'Micro Hexagon' Sensatec Black with Yellow highlight; other upholsteries available
- M leather steering wheel
- Vehicle key with exclusive M designation
- M anthracite headliner
- M interior trim finishers in Aluminium Hexagon Anthracite; other trims available
- Gear lever with M designation<sup>1</sup>
- Exclusive LED optical fibre in the door trims



■ 19" M light alloy wheels Y-spoke style 722 M, Orbit Grey, gloss-lathed with runflat tyres, wheel size 8J x 19 with 225/45 R19 tyres.

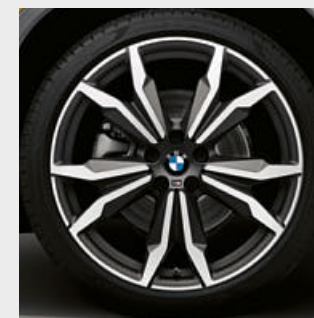

□ 20" M light alloy wheels Double-spoke style 717 M\*, Orbit Grey matt, gloss-lathed with run-flat tyres, wheel size 8J x 20 with 225/40 R20 tyres.



■ A statement for absolute dynamics at first glance: The M door sill finishers accelerate the pulse immediately after opening the door.

<sup>1</sup> Only available in conjunction with manual transmission.

\* The availability of some equipment features and functions depends on engine variants or additional options. The market and production availability may vary. You can find detailed information about terms, standard and optional equipment at [www.bmw.com](http://www.bmw.com) or at your BMW Partner.

Discover even more with the new BMW Products app. Available now, for your smartphone and tablet.

■ Standard equipment □ Optional equipment



■ The M Leather steering wheel including multifunction buttons, an M badge and an integrated driver-side airbag is featured in three-spoke design. With a steering wheel rim in leather 'Walknappa' Black with black stitching and contoured thumb rests, it provides a direct, athletic steering experience.



■ The M Sport seats with integrated headrests offer the driver and front passenger excellent support with their deep seats and high side bolsters, also during fast driving on changing bends.

### Edition GoldPlay exterior equipment ranges:

- exclusive Sanremo Green paintwork
- exclusive M Mesh radiator grille in high-gloss Black with Gold frame
- exclusive exterior mirror caps in Gold
- exclusive M aerodynamics wheel with Gold highlights
- foil on front side panel, doors and rear side section with Gold "GoldPlay" graphic
- in connection with M high-gloss Shadowline exterior trim with extended elements including tailpipe trim and ring around the tailgate badge in high-gloss Black
- M designation on the sides
- Available in connection with other paintwork: Alpine White, M Misano Blue metallic, Black Sapphire, Storm Bay metallic, Skyscraper Grey metallic, Frozen Pure Grey metallic, Frozen Black metallic

### Edition GoldPlay interior equipment ranges:

- decorative strip in Dark Graphite matt with Gold "GoldPlay" graphic on the passenger's side of the instrument panel
- front door sill cover strip sills with Gold "Edition" inscription
- M sport seat in black leather (centre section of the backrest perforated) with integrated head restraint and highlights as well as seams in Gold/Yellow
- M driver footrest in stainless steel look
- M specific pedals
- M identification on vehicle key with high-gloss black insert
- floor mats in Anthracite with yellow edge binding

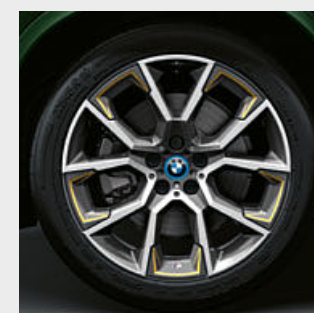

■ 19" M aerodynamic wheels 919 M Multicolour with Gold accent, gloss-lathed, wheel size 8J x 19 with 225/45 R19 tyres.



□ 20" M aerodynamic wheels 920 M Multicolour with Gold accent and run-flat tyres, gloss-lathed, wheel size 8J x 20 with 225/40 R20 tyres.<sup>1,\*</sup>

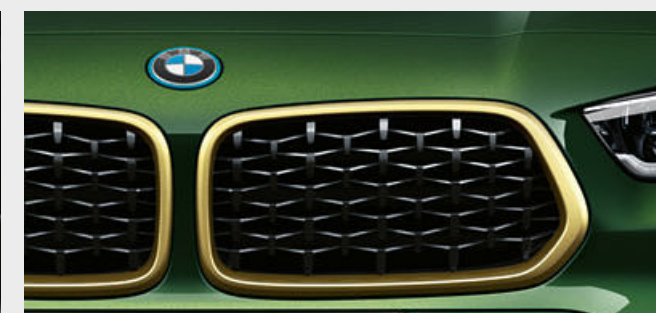

■ The BMW kidney grille in mesh design is completely finished in Black high-gloss and has an elaborately designed grid inside. This grid structure, inspired by racing, lends depth and value to the front and sets a high-quality and dynamic accent in the details.

<sup>1</sup> Only available in conjunction with M Sport suspension.

\* The availability of some equipment features and functions depends on engine variants or additional options. The market and production availability may vary. You can find detailed information about terms, standard and optional equipment at [www.bmw.com](http://www.bmw.com) or at your BMW Partner.

# BMW X2 M35i.

Discover even more with the new BMW Products app. Available now, for your smartphone and tablet.



■ The compact M Leather steering wheel in the particularly narrow M specific three-spoke design impresses with a phenomenal feel, a sporty look and very modern technology.

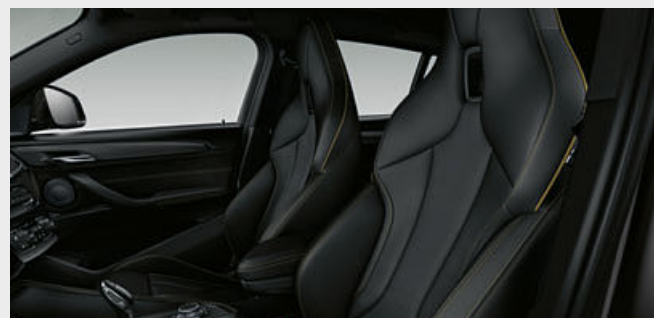

□ The M Sport seats\* with integrated headrests offer the driver and front passenger excellent support with their deep seats and high side bolsters, also during fast driving on changing bends.



■ As soon as the doors are opened, the Edition door sill cover strip catches the eye thanks to its high-quality contrasting Galvanic Gold finish.



□ 20" M light alloy wheels Double-spoke style 721 M, Cerium Grey, burnished, with runflat tyres, wheel size 8J x 20 with 225/40 R20 tyres.

# xDRIVE 25e.

Equipment 30 | 31

#joyelectrified by

■ Standard equipment □ Optional equipment



■ The port for external charging of the high-voltage battery is located behind a flap on the vehicle's front side panel on the left. This protects the socket from environmental influences. An LED display indicates the current charging status.



■ With the hybrid-specific instrument cluster, you always have all the relevant information about the innovative plug-in hybrid drive at your fingertips. For example, you can read the output display of the electric motor as well as the charge level indicator and the purely electric and combined range.



■ The "xDrive25e" model inscription is on the right side of the tailgate.

\* The availability of some equipment features and functions depends on engine variants or additional options. The market and production availability may vary. You can find detailed information about terms, standard and optional equipment at [www.bmw.com](http://www.bmw.com) or at your BMW Partner.



# ADDITIONAL EQUIPMENT.

Discover even more with the new BMW Products app. Available now, for your smartphone and tablet.

■ Standard equipment □ Optional equipment



□ The Adaptive LED headlights include a 4-segment matrix high-beam headlight function and turn indicators with LED technology. The equipment also features cornering lights, daytime running lights and adaptive light control for an illumination of the road adapted to the driving situation.



□ The opened panorama glass roof provides ample fresh air while it creates a bright, light-flooded atmosphere in the interior when closed. It opens and closes completely automatically at the push of a button or with the vehicle key and is equipped with slide and lift functions, a roller sunblind and wind deflector.

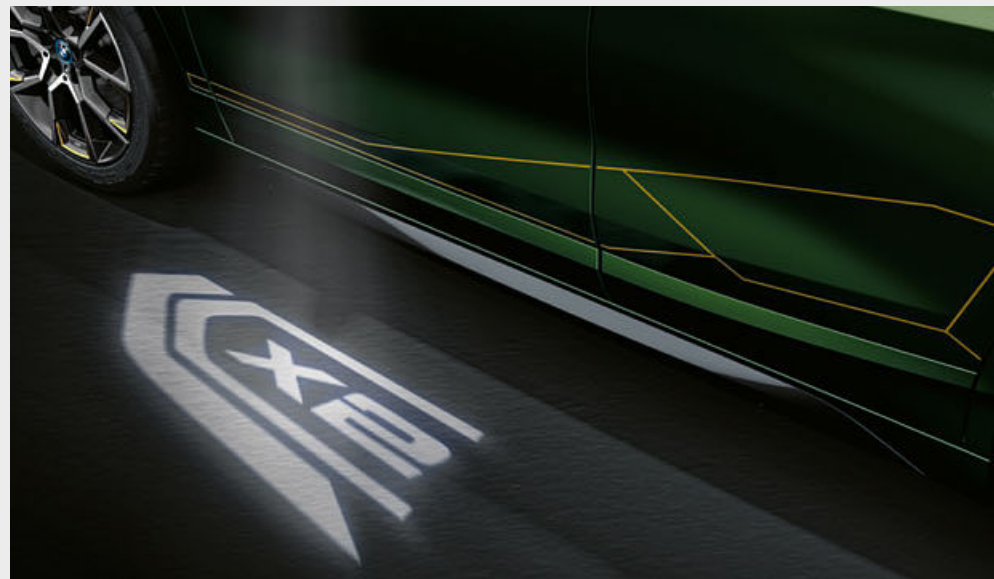

□ The atmospheric Light package\* contains various LED lights and yields an ambience of pure quality. The driver is greeted with an impressive welcome display with exterior LEDs and an X2 LED projection. Ambient light atmospherically lights up the interior with a stylish combination of direct and indirect lights.



□ The M roof rails high-gloss Shadow Line in Black high-gloss adds a premium-quality touch. Lying flat on the roof, it forms the basis for a multifunctional BMW roof rack unit that carries a roof box, bikes, surf boards etc. easily and securely.



□ The M seat belts<sup>1</sup>\* with belt tensioner and belt force limiter boast an exquisite woven highlight in the classic M colours.



□ The mirror caps\* are painted in Black high-gloss instead of the body colour. They emphasise the vehicle's athletic look and create an individual appearance.



□ The BMW kidney grille in mesh design underlines the dynamic appearance of the vehicle in the front view as a central visual detail.



□ The powerful M Sport brake<sup>1</sup>\* features large brake discs and exclusive brake calipers painted in Blue metallic with the M logo.



□ The powerful M Sport brake<sup>1</sup>\* features large brake discs and exclusive brake calipers painted in Red high-gloss with the M logo.



■ The LED headlights with extended contents offer a bright and efficient bi-LED light for low and high-beam headlights. The cornering and bending lights with LED technology enable variable light distribution with increased side illumination for city driving. In poor visibility conditions, they also function as bad weather light.

<sup>1</sup> Only available for M35i, M Sport package, M Sport X package and Goldplay Edition.

\* The availability of some equipment features and functions depends on engine variants or additional options. The market and production availability may vary. You can find detailed information about terms, standard and optional equipment at [www.bmw.com](http://www.bmw.com) or at your BMW Partner.

# ADDITIONAL EQUIPMENT.

Discover even more with the new BMW Products app. Available now, for your smartphone and tablet.

■ Standard equipment □ Optional equipment



□ The sport seats\* have high seat and backrest bolsters, providing optimal support for the driver and front passenger even during athletic driving on bends. In contrast to the standard seats, their seat angle, seat depth, thigh rests and the armrest width on the driver's seat can be individually adjusted. Their special design highlights the vehicle's athletic capabilities.



■ The through-loading system with rear seat backrests that can be folded down in a 40:20:40 split, guarantees flexibility when transporting bulky objects.  
□ The Ski and snowboard bag makes it possible to transport skis or snowboards cleanly and safely.



□ The 8-speed Steptronic Sport transmission\* offers incredibly sporty gear changes. Whether automatic or manual using gearshift paddles or gear lever.



□ The Seat heating for driver and front passenger allows for heating of the entire seat base and backrest.



□ The full-colour BMW Head-Up Display<sup>1</sup>\* projects information relevant to the journey directly into the driver's field of vision, thereby allowing them to fully concentrate on driving. The display includes information such as the current speed, navigation directions, Speed Limit Info incl. no-overtaking indicator, along with telephone and entertainment lists.



□ The black Sport leather steering wheel with three spokes features a Chrome decorative trim. A thick rim and contoured thumb rests provide an exceptionally pleasant, high-grip feel. The gear lever also comes in leather.



□ The Steering-wheel heating\* quickly warms up the rim of the steering wheel at the push of a button, which is especially comfortable in winter.



□ Cruise control with braking function\* saves any selected speed above 30 km/h and maintains it even while going downhill.



□ The safety package Driving Assistant<sup>2</sup>\* includes camera-based assistance systems, such as Lane Departure Warning, Collision Warning, High-beam Assistant and Speed Limit Info. The Collision Warning and Pedestrian Warning with light city braking function warns of collisions at speeds between 10 and 60 km/h, while the Lane Departure Warning causes the steering wheel to vibrate as a warning when the lane is unintentionally changed at 70 km/h or over.



□ The navigation system features a built-in 8.8" touch display and an instrument cluster with extended features. Route guidance is provided via an arrow or map display, or with spoken instructions. The system is operated intuitively using either the iDrive Controller, intelligent voice control or the touchscreen with interactive tiles that display live content.



□ Navigation Plus\* features a BMW Head-Up Display<sup>1</sup>, an iDrive Controller, a built-in 10.25" touch display and an instrument cluster with high-resolution 5.7" TFT display. The system is operated intuitively using either the iDrive Controller, the direct menu control buttons and eight functional bookmarks, intelligent voice control or the touchscreen with interactive tiles.

<sup>1</sup> The information in the BMW Head-Up Display is not fully visible when viewed through polarised sunglasses. Content shown will depend on the equipment options chosen. Further optional equipment is required to display specific items.  
<sup>2</sup> Function may be limited in darkness, fog or bright glare.

\*The availability of some equipment features and functions depends on engine variants or additional options. The market and production availability may vary. You can find detailed information about terms, standard and optional equipment at [www.bmw.com](http://www.bmw.com) or at your BMW Partner.

# EXTERIOR COLOURS.

Discover even more with the new BMW Products app. Available now, for your smartphone and tablet.

■ Standard equipment □ Optional equipment



□ Non-metallic 300 Alpine White<sup>1</sup>



■ Non-metallic 668 Black



□ Metallic A96 Mineral White

## GOLDPLAY EDITION



□ Metallic C4P M Brooklyn Grey\*

## M SPORT PACKAGE M SPORT X PACKAGE



□ Metallic C1D M Misano Blue\*

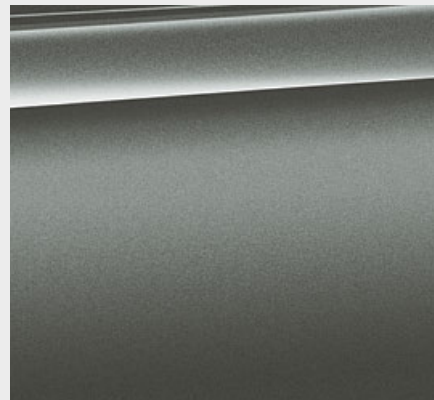

□ Metallic C4W Skyscraper Grey<sup>5</sup>

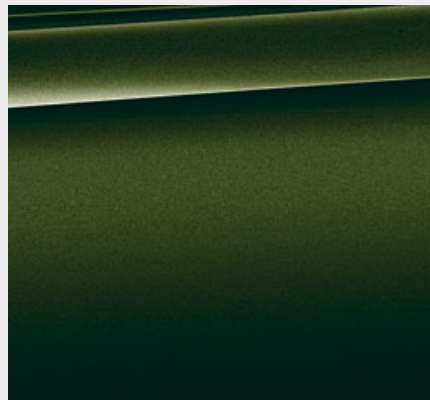

□ Metallic C4E Sanremo Green<sup>5</sup>



□ Metallic 475 Black Sapphire<sup>3,\*</sup>

## BMW INDIVIDUAL



□ BMW Individual C3N Storm Bay metallic<sup>2</sup>

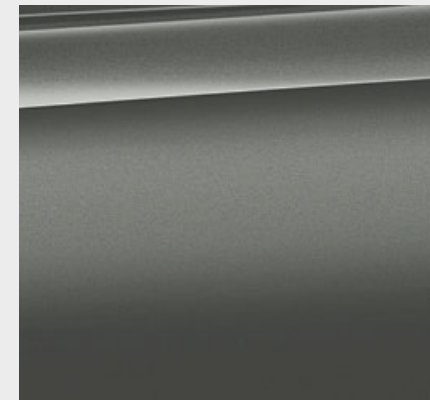

□ BMW Individual C5A Frozen Pure Grey metallic<sup>6</sup>

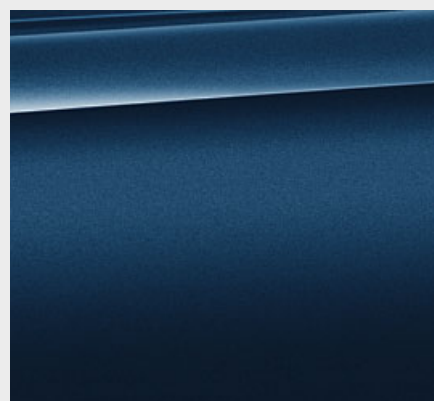

□ Metallic C1M Phytionic Blue<sup>4,\*</sup>



□ Metallic C1X Sunset Orange<sup>3,\*</sup>



□ Metallic C1P Galvanic Gold<sup>2</sup>

**[Colour samples]** These colour samples are intended as an initial guide to the colours and materials available for your BMW. However, experience has shown that printed versions of paint, upholstery and interior trim colours cannot in all cases faithfully

reproduce the appearance of the original colour. Please discuss your preferred colour choices with your BMW partner or dealership. There you can also see original samples and be assisted with special requests.

<sup>1</sup> Available as standard for M Sport package and M Sport X package. Also optionally available for Goldplay Edition.

<sup>2</sup> Also optionally available for M Sport package and M Sport X package.

<sup>3</sup> Optionally also available for M Sport package, M Sport X package and Goldplay Edition.

<sup>4</sup> Optionally also available for M Sport X package and Goldplay Edition.

<sup>5</sup> Only available for Goldplay Edition.

<sup>6</sup> Only available for M Sport package.

\* The availability of some equipment features and functions depends on engine variants or additional options. The market and production availability may vary. You can find detailed information about terms, standard and optional equipment at [www.bmw.com](http://www.bmw.com) or at your BMW Partner.

# INTERIOR COLOURS.

Discover even more with the new BMW Products app. Available now, for your smartphone and tablet.

■ Standard equipment □ Optional equipment



## CLOTH

### Available with

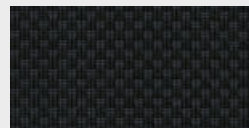

■ Base

Cloth 'Grid' EGAT Anthracite.\*

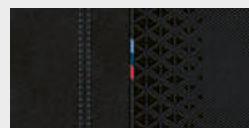

□ M Sport package  
□ M Sport X package

Cloth 'Trigon' HLSW Alcantara Black with blue highlights\*



□ Base

Cloth 'Race' ERL1 Anthracite with Grey highlight.\*

## CLOTH-SENSATEC COMBINATION

### Available with

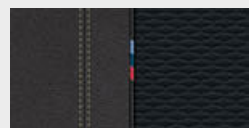

□ M Sport package  
■ M Sport X package

Cloth 'Micro Hexagon' HKJ Sensatec Black, Yellow highlight\*

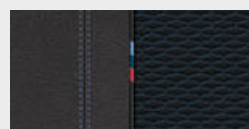

■ M Sport package  
□ M Sport X package

Cloth 'Micro Hexagon' HKSW Sensatec Black, Blue highlight\*

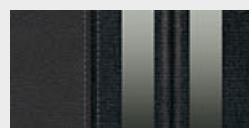

□ M Sport package  
□ M Sport X package

Cloth/Sensatec combination KFL1 Anthracite, accent Grey<sup>1</sup>

## SENSATEC

### Available with

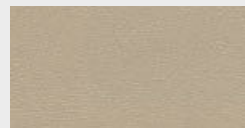

□ Base  
□ M Sport package  
□ M Sport X package

Sensatec KCCX Oyster.



□ Base  
□ M Sport package  
□ M Sport X package

Sensatec KCSW Black.

## LEATHER

### Available with



□ Base  
□ M Sport package  
□ M Sport X package

Leather 'Dakota' PDOA with perforations Oyster and Grey highlight.\*



□ Base  
□ M Sport package  
□ M Sport X package

Leather Dakota PDFM with perforations Magma Red, Grey highlight\*

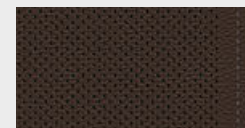

□ Base  
□ M Sport package  
□ M Sport X package

Leather 'Dakota' PDMZ with perforations Mocha.\*



□ M Sport package  
□ M Sport X package

Leather 'Dakota' PDN4 with perforations Black, Blue highlight.\*



□ Base  
□ M Sport package  
□ M Sport X package  
□ Goldplay Edition

Leather 'Dakota' PDSW with perforations Black.\*

## LEATHER-ALCANTARA COMBINATION

### Available with

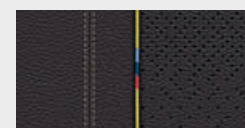

□ Goldplay Edition

Leather 'Dakota' PDIJ with perforations in Black, Yellow highlight

## INTERIOR TRIM FINISHERS

### Available with

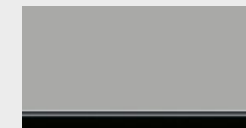

■ Base

Interior trim finishers Oxide Silver dark matt with highlight trim finisher Black high-gloss

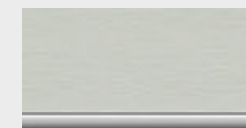

□ Base  
□ M Sport package  
□ M Sport X package

Interior trim finishers Aluminium, finely brushed lengthwise with highlight trim finishers Pearl Chrome



■ M Sport package  
□ M Sport X package

M interior trim finishers Aluminium Hexagon with highlight trim finisher Estoril Blue matt

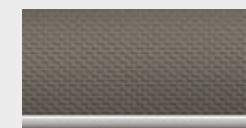

□ M Sport package  
■ M Sport X package  
■ Goldplay Edition

M interior trim finishers Aluminium Hexagon Anthracite with highlight trim finisher Pearl Chrome



□ Base  
□ M Sport package  
□ M Sport X package

Interior trim designed in fine-wood trim 'Fineline' Stream with accent in Pearl Chrome



□ Base  
□ M Sport package  
□ M Sport X package

Interior trim finishers in fine-wood trim oak grain matt with highlight trim finisher Pearl Chrome



□ Base  
□ M Sport package  
□ M Sport X package

Interior trim finishers black high-gloss with highlight trim finisher Pearl Chrome

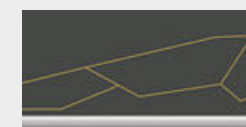

□ Goldplay Edition

Interior trim finishers 'Dark Graphite' matte

Please note that even normal long- or short-term use can lead to unrecoverable upholstery damage. This can be caused in particular by non-colourfast clothing.

Please note that the interior colour depends on the selected upholstery colour.

<sup>1</sup> Only available for xDrive25e.

\* The availability of some equipment features and functions depends on engine variants or additional options. The market and production availability may vary.

You can find detailed information about terms, standard and optional equipment at [www.bmw.com](http://www.bmw.com) or at your BMW Partner.

# WHEELS AND TYRES.

Discover even more with the new BMW Products app. Available now, for your smartphone and tablet.



■ 17" light alloy wheels V-spoke style 560, Reflex Silver with runflat tyres, wheel size 7.5J x 17 with 225/55 R17 tyres.\*



□ 17" light alloy wheels Double-spoke style 564 Reflex Silver, wheel size 7.5J x 17 with 225/55 R17 tyres.1.\*

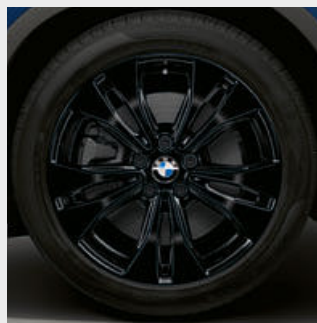

□ 18" light alloy wheels Double-spoke style 578 Jet Black, wheel size 7.5J x 18 with 225/50 R18 tyres.\*



□ 18" light alloy wheels Y-spoke style 579 Bicolour Orbit Grey, gloss-lathed, wheel size 7.5J x 18 with 225/50 R18 tyres.\*



□ 19" light alloy wheels Y-spoke style 511 Orbit Grey, gloss-lathed with runflat tyres, wheel size 8J x 19 with 225/45 R19 tyres.\*



□ 19" M light alloy wheels Double-spoke style 715 M, Orbit Grey, gloss-lathed with run-flat tyres, wheel size 8J x 19 with 225/45 R19 tyres.2,3



□ 19" M aerodynamic wheels 919 M Bicolour Gunmetal Grey, gloss-lathed, wheel size 8J x 19 with 225/45 R19 tyres.4



□ 19" M aerodynamic wheels 919 M Multicolour with Gold accent, gloss-lathed, wheel size 8J x 19 with 225/45 R19 tyres.4



□ 20" M light alloy wheels Double-spoke style 716 M, Jet Black, gloss-lathed with runflat tyres, wheel size 8J x 20 with 225/45 R20 tyres.2



□ 20" M light alloy wheels Double-spoke style 717 M, Orbit Grey matt, gloss-lathed with run-flat tyres, wheel size 8J x 20 with 225/40 R20 tyres.5



□ 20" M aerodynamic wheels 920 M Bicolour Midnight Grey with run-flat tyres, gloss-lathed, wheel size 8J x 20 with 225/40 R20 tyres.4,6,\*



□ 20" M aerodynamic wheels 920 M Multicolour with Gold accent and run-flat tyres, gloss-lathed, wheel size 8J x 20 with 225/40 R20 tyres.4,6,\*

1 Available as standard for xDrive25e.

2 Only available in conjunction with M Sport package and M Sport X package.

3 Available as standard for M35i.

4 Only available in conjunction with the Goldplay Edition.

5 Optionally also available for M Sport package, M Sport X package and BMW M35i.

6 Only available in conjunction with M Sport suspension.

\*The availability of some equipment features and functions depends on engine variants or additional options. The market and production availability may vary. You can find detailed information about terms, standard and optional equipment at [www.bmw.com](http://www.bmw.com) or at your BMW Partner.

# ORIGINAL BMW ACCESSORIES.

■ Standard equipment □ Optional equipment ○ Accessories



○ The high-quality 19" light alloy wheels V-spoke style 573 are designed in Bicolor Black, bright turned on the visible side and weight-optimised. Summer complete wheel set with run-flat tyres, wheel size 8J x 19 with tyre size 225/45 R19 92W RSC.



○ The modern BMW roof box in black with titanium silver side panels has a storage capacity of 420 litres and is compatible with all BMW roof rack systems. Due to the fact that it can be opened from both sides and has triple central locking on each side it is convenient to load and lock for theft protection.



○ In the event of disturbances, the highly sensitive full-HD camera automatically records the situation in front of and behind the car.



○ Secure hold for any 9.7" Apple iPad™ 2, 3 or 4. The holder is attached to the basic carrier or to the optional equipment "Travel & Comfort".



○ The high-quality 18" light alloy wheels, Y-spoke style 566 are designed in black and lend the vehicle a very sporty appearance. TPMS summer complete wheel set with run-flat tyres, wheel size 7.5J x 18 with tyre size 225/50 R18 95W RSC.



○ The durable, anti-slip, water-resistant fitted mat with raised borders on all sides and a shapely design protects the luggage compartment from dirt and moisture. Designed in black with a black X2 inlays that perfectly match the interior.

Discover the wide range of innovative solutions available for the exterior and interior, communication and information, and for transportation and the luggage compartment. Your BMW Partner is on hand to advise you on the whole range of

Original BMW Accessories and the BMW M Performance Parts product portfolio. For further information, please visit [www.bmw.com](http://www.bmw.com)

BMW X2		sDrive18i	sDrive20i	xDrive20i	M35i	sDrive18d	xDrive18d	sDrive20d	xDrive20d	xDrive25d	xDrive25e <sup>11</sup>
--------	--	-----------	-----------	-----------	------	-----------	-----------	-----------	-----------	-----------	-------------------------

Weight											
Unladen weight EU <sup>1</sup>	kg	1485 [1505]	[1545]	[1640]	[1690]	1585 [1615]	[1680]	[1620]	[1680]	[1695]	[1805]
Maximum permissible weight	kg	1985 [2005]	[2055]	[2145]	[2190]	2080 [2115]	[2180]	[2125]	[2190]	[2170]	[2300]
Permitted load	kg	575 [575]	[585]	[580]	[575]	570 [575]	[575]	[580]	[585]	[550]	[570]
Permitted trailer load, unbraked <sup>2</sup>	kg	740 [750]	[750]	[750]	-	750 [750]	[750]	[750]	[750]	[750]	-
Permitted trailer load, braked, max. 12% gradient/max. 8% gradient <sup>2</sup>	kg	1700/1700 [1700/1700]	[1800/1800]	[2000/2000]	-	1800/1800 [1800/1800]	[1800/1800]	[1800/1800]	[2000/2000]	[2000/2000]	-
Luggage capacity	l	470-1355	470-1355	470-1355	470-1355	470-1355	470-1355	470-1355	470-1355	470-1355	410-1290

BMW TwinPower Turbo engine <sup>3</sup>											
Cylinders/valves	-	3/4	4/4	4/4	4/4	4/4	4/4	4/4	4/4	4/4	3/4
Capacity	cm <sup>3</sup>	1499	1998	1998	1998	1995	1995	1995	1995	1995	1499
Max. output/engine speed	kW (hp)/rpm	100 (136)/4500-6500	131 (178)/5000-5500	131 (178)/5000-5500	225 (306)/5000-6250	110 (150)/4000	110 (150)/4000	140 (190)/4000	140 (190)/4000	170 (231)/4400	92 (125) <sup>10</sup> /5000-5500
Max. torque/engine speed	Nm/rpm	220/1500-4100	280/1350-4200	280/1350-4200	450/1800-4500	350/1750-2500	350/1750-2500	400/1750-2500	400/1750-2500	450/1500-3000	220/1500-3800

eDrive motor											
Max. output	kW (hp)	-	-	-	-	-	-	-	-	-	70 (95)
Max. torque	Nm	-	-	-	-	-	-	-	-	-	165
System output	kW (hp)	-	-	-	-	-	-	-	-	-	162 (220)
System torque	Nm	-	-	-	-	-	-	-	-	-	385

Lithium-ion high-voltage battery											
Battery type/net battery capacity	kWh	-	-	-	-	-	-	-	-	-	Li-ion/8.82
Electric range (EAER) <sup>6,7</sup>	km	-	-	-	-	-	-	-	-	-	51-53
Electric range urban (EAER city) <sup>6,7</sup>	km	-	-	-	-	-	-	-	-	-	59
Charging time (AC rapid charging with BMW Wallbox) <sup>8</sup>	h	-	-	-	-	-	-	-	-	-	3.2

Power transmission											
Type of drive	-	Front-wheel	Front-wheel	All-wheel	All-wheel	Front-wheel	All-wheel	Front-wheel	All-wheel	All-wheel	Electric all-wheel drive
Standard transmission	-	6-speed manual	7-speed DCT	8-speed Steptronic	8-speed Steptronic Sport	6-speed manual	8-speed Steptronic	8-speed Steptronic	8-speed Steptronic	8-speed Steptronic	6-speed Steptronic

Performance											
Top speed	km/h	205 [205]	[227]	[224]	[250] <sup>5</sup>	207 [207]	[206]	[224]	[221]	[237]	[195]
Top electric speed	km/h	-	-	-	-	-	-	-	-	-	[135]
Acceleration 0-100 km/h	s	9.6 [9.6]	[7.6]	[7.3]	[4.9]	9.3 [9.3]	[9.4]	[7.9]	[7.7]	[6.6]	[6.8]

Consumption <sup>3,4</sup> - All engines conform to the EU6 standard											
Low	l/100 km	8.8-8.6 [9.2-8.6]	[9.7-9.1]	[10.4-9.9]	[10.7-10.4]	6.5-5.9 [6.8-6.4]	[7.4-6.6]	[7.0-6.7]	[7.6-6.5]	[7.7-7.0]	[9.6-9.5]
Medium	l/100 km	6.8-6.0 [6.9-6.2]	[7.0-6.4]	[7.6-6.9]	[8.0-7.4]	5.2-4.7 [5.7-5.1]	[6.2-5.4]	[5.8-5.0]	[6.3-5.2]	[6.3-5.6]	[6.5-6.4]
High	l/100 km	6.0-5.2 [6.1-5.3]	[6.1-5.3]	[6.4-5.7]	[7.0-6.4]	5.0-4.5 [5.2-4.6]	[5.4-4.9]	[5.2-4.7]	[5.6-4.8]	[5.7-5.1]	[6.3-6.2]
Maximum value	l/100 km	7.1-6.0 [7.3-6.2]	[7.3-6.3]	[7.6-6.7]	[8.1-7.4]	5.9-5.1 [6.0-5.2]	[6.1-5.5]	[5.9-5.2]	[6.3-5.5]	[6.3-5.7]	[8.1-7.8]
Combined (PHEV weighted)	l/100 km	6.9-6.1 [7.1-6.2]	[7.2-6.4]	[7.6-6.8]	[8.1-7.5]	5.6-4.9 [5.8-5.2]	[6.1-5.4]	[5.8-5.2]	[6.3-5.4]	[6.3-5.7]	1.8-1.7
Energy consumption (ECAC weighted) <sup>9</sup>	kWh/100 km	-	-	-	-	-	-	-	-	-	15.2-14.9
Exhaust emissions standard (type-certified)	-	EU6d	EU6d	EU6d	EU6d	EU6d	EU6d	EU6d	EU6d	EU6d	EU6d
Combined CO <sub>2</sub> emissions (PHEV weighted)	g/km	157-138 [161-142]	[164-145]	[174-156]	[185-170]	146-129 [152-135]	[160-142]	[153-136]	[164-141]	[165-148]	42-38
Tank capacity (approx.) standard	l	51	51	61	61	51	51	51	51	51	36

BMW X2		sDrive18i	sDrive20i	xDrive20i	M35i	sDrive18d	xDrive18d	sDrive20d	xDrive20d	xDrive25d	xDrive25e <sup>11</sup>
--------	--	-----------	-----------	-----------	------	-----------	-----------	-----------	-----------	-----------	-------------------------

Wheels/tyres											
Tyre dimensions		225/55 R17 97 W	225/55 R17 97 W	225/55 R17 W	225/45 R19 W	225/55 R17 W	225/55 R17 W	225/55 R17 W	225/55 R17 W	225/55 R17 W	225/55 R17 W
Wheel size		7.5J x 17	7.5J x 17	7.5J x 17	8J x 19	7.5J x 17	7.5J x 17	7.5J x 17	7.5J x 17	7.5J x 17	7.5J x 17
Material		Light alloy	Light alloy	Light alloy	Light alloy	Light alloy	Light alloy	Light alloy	Light alloy	Light alloy	Light alloy

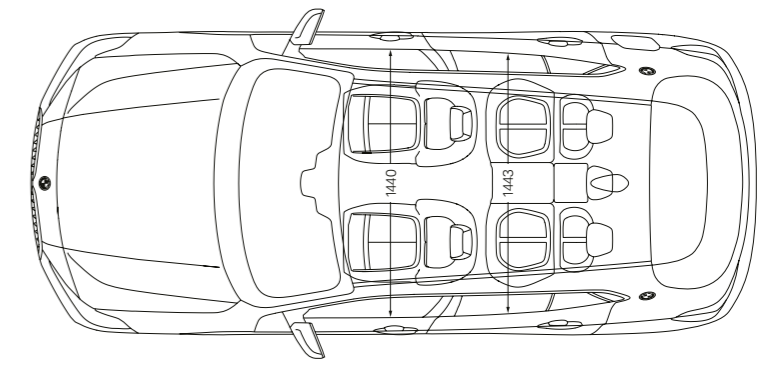
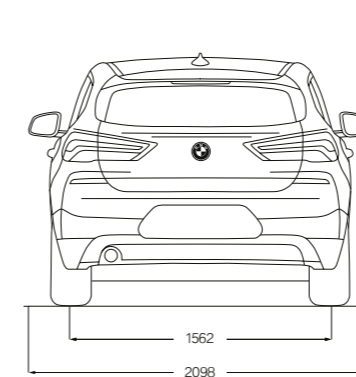
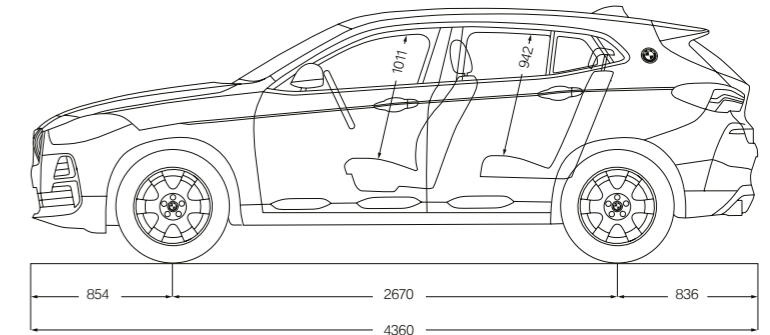
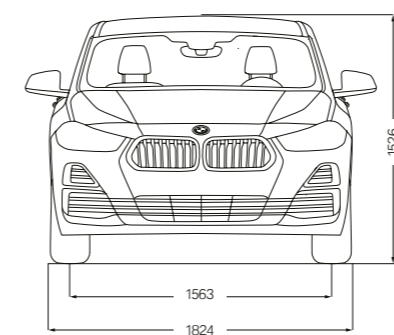

The dimensions in the technical drawing are in millimetres and may vary depending on the model and optional equipment. The figures for mileage, consumption, CO<sub>2</sub> emissions and power consumption refer to vehicles with standard transmission. Figures in [ ] are for vehicles with Steptronic transmission.

<sup>1</sup> The EC unladen weight refers to a vehicle with standard equipment and does not include any optional extras. The unladen weight includes a 90% full tank and a driver weight of 75 kg. Optional equipment may affect the weight of the vehicle, the payload and the top speed if the selected equipment has an impact on the vehicle's aerodynamics.

<sup>2</sup> The actual total weight of the trailer must not exceed the maximum trailer load, taking into account the maximum tow bar download.

<sup>3</sup> Performance data of petrol engines apply to vehicles using RON 98 fuel. Fuel consumption data apply to vehicles using reference fuels in accordance with EU Regulation 715/2007. Unleaded RON 91 and higher with a maximum ethanol content of 10% (E10) may also be used. BMW recommends RON 95 unleaded premium grade fuel.

<sup>4</sup> Official data for fuel consumption, CO<sub>2</sub> emissions, power consumption and electric range was determined in accordance with the prescribed measuring procedure and corresponds to European Regulation (EU) 715/2007 in the applicable version. For ranges, data determined as per WLTP takes into account any optional equipment (available on the German market in this case). For vehicles that have been newly type approved since 1 January 2021, only the official data according to WLTP exists. For more information about NEDC and WLTP measuring procedures visit [www.bmw.com/wltp](http://www.bmw.com/wltp)

<sup>5</sup> Electronically limited.

<sup>6</sup> Range depends on the equipment and various factors. In particular: personal driving style, route characteristics, exterior temperature, heating/air conditioning, pre-conditioning and the chosen equipment.

<sup>7</sup> EAER (equivalent all electric range).

<sup>8</sup> Dependent on the local electricity infrastructure. Charging time corresponds to a charge of 100% of maximum capacity.

<sup>9</sup> ECAC (charge-depleting electric consumption).

<sup>10</sup> Depending on the environmental conditions, a temporary peak performance is provided, which can be approx. 10 % higher than the rated output. Peak performance duration increases with decreasing ambient temperature (at +25°C approx. 5 s, at -20°C approx. 40 s).

<sup>11</sup> At temperatures below freezing, the fully electric drive system on this plug-in hybrid is only available after a few kilometres of driving, once the battery has heated to operational temperature.



## ALL BMW MODELS IN ONE APP.

DOWNLOAD THE **BMW Products** APP NOW  
AND DISCOVER THE PLEASURE OF DRIVING.

### **BMW X2 xDRIVE20i WITH EDITION GOLDPLAY:**

BMW TwinPower Turbo 4-cylinder petrol engine, 131 kW (178 hp), 20" M aerodynamic wheels 920 M Multicolour Gold accent with run-flat tyres, exterior colour in Sanremo Green, M sport seats for driver and front passenger in leather 'Dakota' with perforations and gold stitching.

The models illustrated in this medium show the equipment and configuration options (standard and optional) for vehicles produced by BMW AG for the German market. Some of the equipment features shown or described here are available as optional equipment at an extra charge. The availability of some equipment features depends on engine variants or additional options. Alterations in standard and optional equipment and the configurations available for the different models or special market requirements, as described in this brochure, may occur after 11/12/2021, the date when this brochure went to press. Your local BMW Partner is available to provide further details. Subject to change in design and equipment. Of course, each vehicle is designed for economical recycling after its long-running life. You can find more information regarding your end-of-life vehicle on our website [www.bmw.de/recycling](http://www.bmw.de/recycling) © BMW AG, Munich, Germany.

Reproduction, even in part, only with the written approval of BMW AG, Munich.